

Specifications

Electrical Housing: NEMA 4X water tight enclosure
Power Consumption: .25A @ 120 VAC
Auto Sensing 120v - 277 VAC 50/60 Hz.
Lamps: 1 - 22" Lamp w/ T3 Quartz

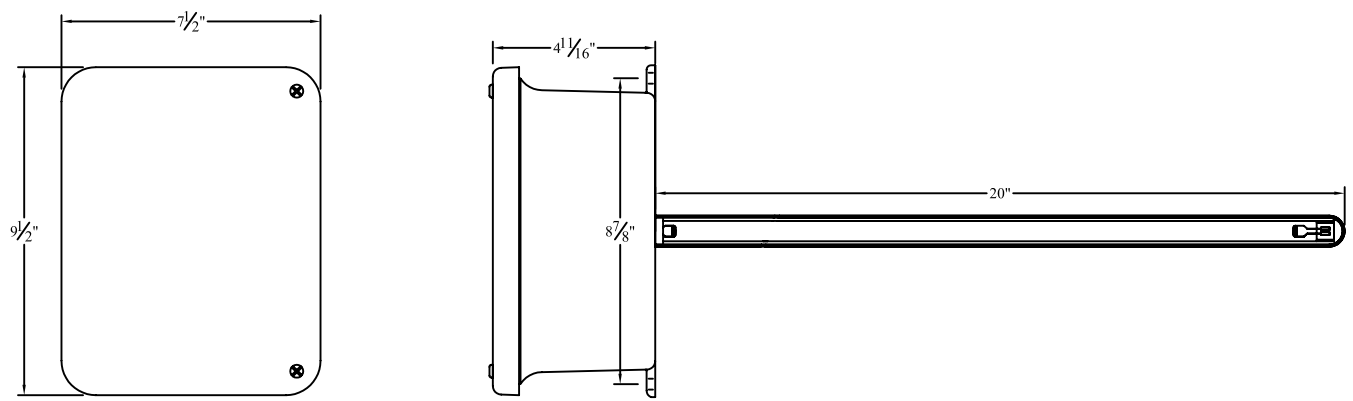
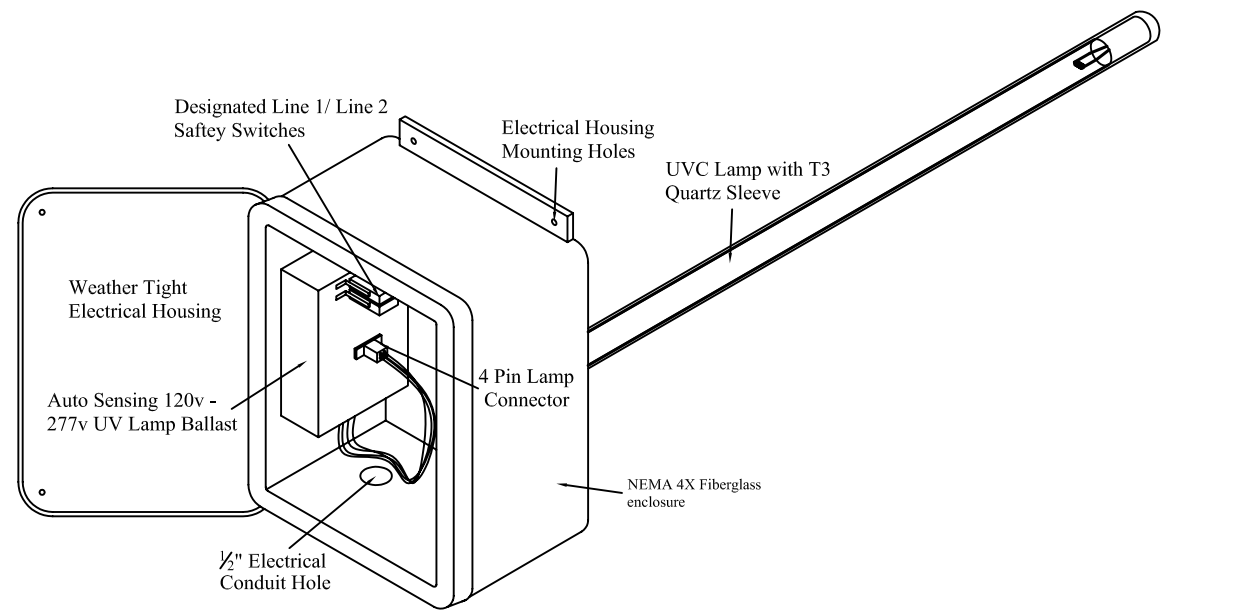

Ultravation, Inc. 212 Ideal Way. Poultney Vermont 05764. Ph: 802-287-9735 Fx: 802-287-9203 www.Ultravation.com	Part #: UVMatrix 4X-122	Drawing #: DC-IH-3243	Rev -*
	Description: Outdoor UV System with 22" lamp wrapped in out T3 Quartz 120-277 VAC		
	Date: 3/7/08	Scale:	Creator: JSM