

Specifications

Housing Material: Powder Coated Galvanized Steel
Input Power: 120 VAC 60 Hz.
Power Consumption: 44.5 Va.
Total UV Output: 16 UVC Watts @ 254 nm
Number of Lamps: 1 - 33" UVC (AS-IH-0614, No Ozone production)
Electrical Connections: Multiple 1/2" & 3/4" Knockouts
Air Flow: 67 CFM
Noise Level: 34.00 dB Fan

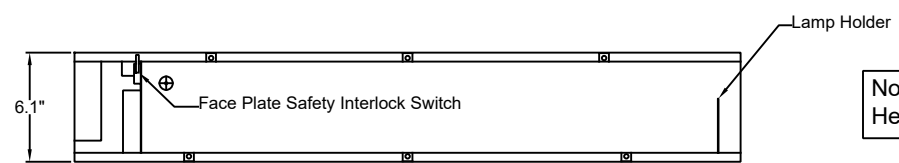

Note: Minimum Installation Height of 7' to Bottom of Fixture

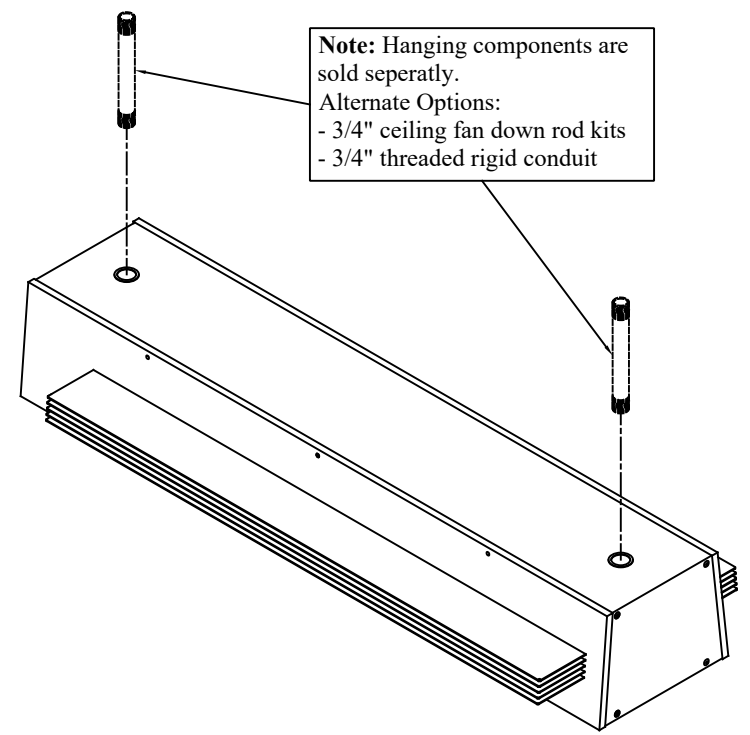
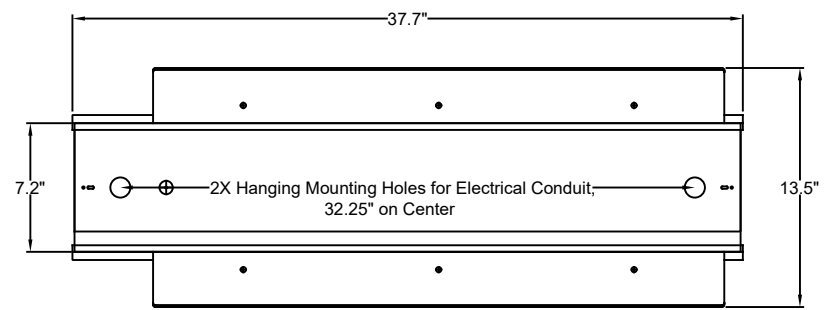
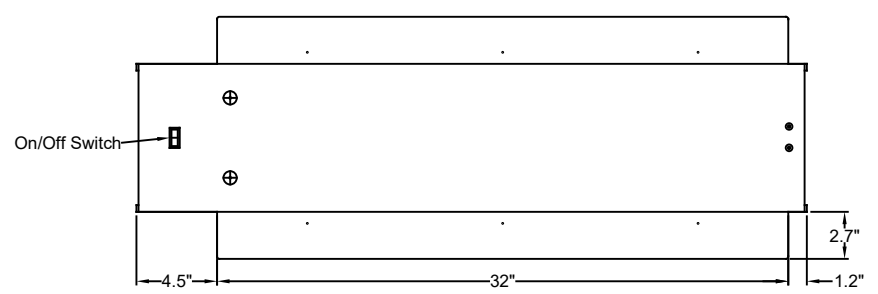
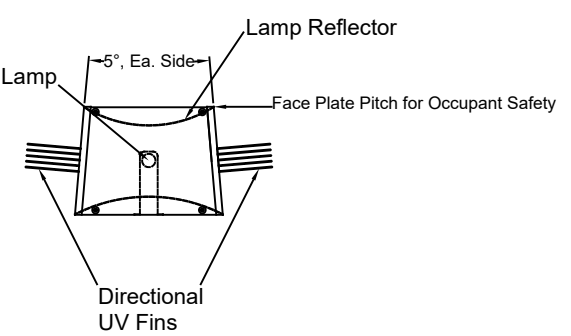
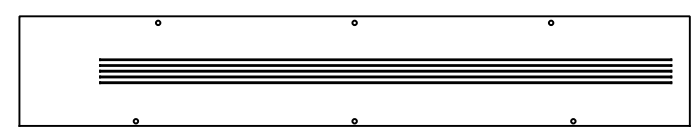
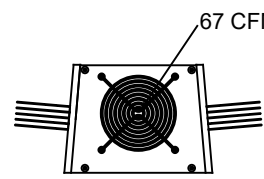

Ultravation, Inc. 212 Ideal Way. Poultney, Vermont 05764. Ph: 802-287-9735 Fx: 802-287-9203 www.Ultravation.com	Part #: UVMatrix FS-33F-CR	Drawing #: FS33FCR-DSS	Rev - C
	Description: BioGard Series UVMatrix FS-33F-CR Upper Room UVC with 67 CFM fan for increased room circulation, Center of room installation with 1-33" Germicidal Lamp for Area Coverage of 700 ft ² at maximum dimensions of 16' wide x 44' deep.		
Date: 1/5/21	Scale:	Creator: JSM	