

Specifications

Housing Material: Powder Coated Galvanized Steel
Input Power: 120 VAC 60 Hz.
Power Consumption: 36 Va.
Total UV Output: 16 UVC Watts @ 254 nm
Number of Lamps: 1 - 33" UVC (AS-IH-0614, No Ozone production)
Electrical Connections: Multiple 1/2" & 3/4" Knockouts

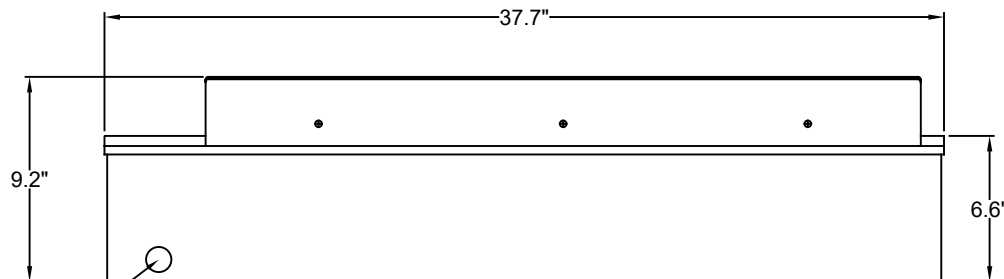

Electrical Connections

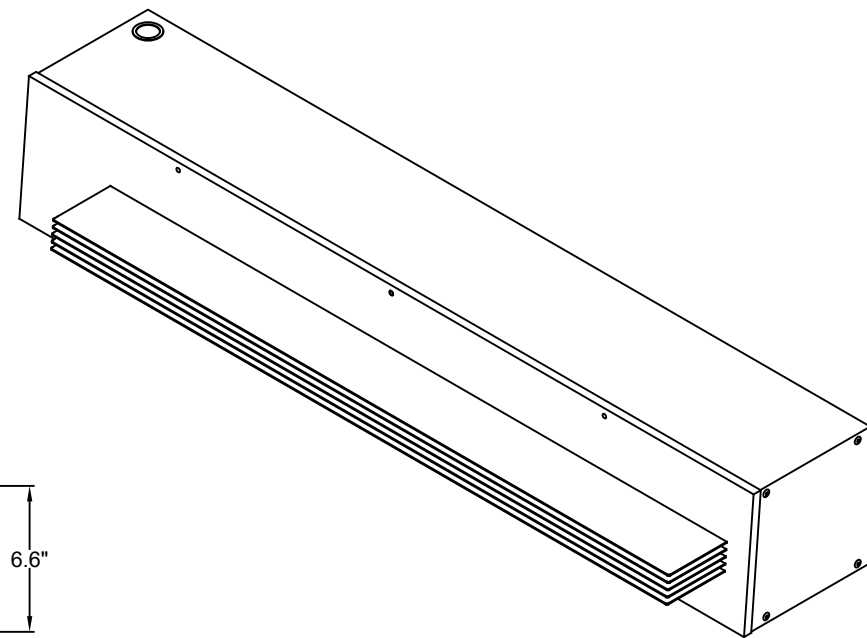
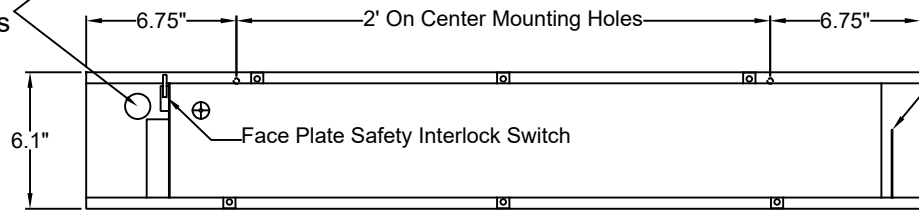

Note: Minimum Installation Height of 7' to Bottom of Fixture

Lamp Reflector

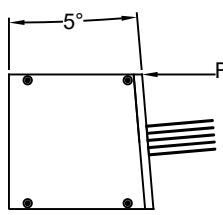
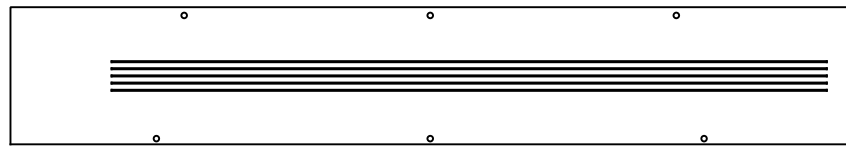
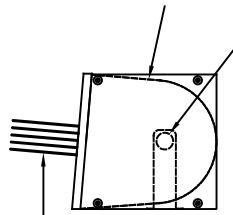

Face Plate Pitch for Occupant Safety

Directional UV Fins

On/Off Switch

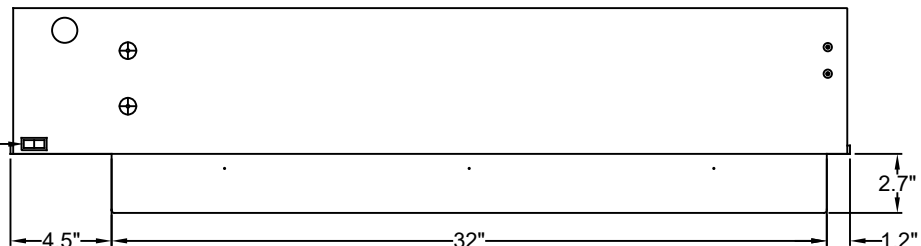

Ultravation, Inc.

212 Ideal Way.
 Poultney, Vermont 05764.
 Ph: 802-287-9735
 Fx: 802-287-9203
 www.Ultravation.com

Part #UVMatrix FS-33	Drawing #: FS33-DSS	Rev - B
----------------------	---------------------	---------

Description:
 BioGard Series UVMatrix FS-33 Upper Room UVC,
 1- 33" Germicidal Lamp with Area Coverage of 350 ft² at
 maximum dimensions of 16' Wide x 22' Deep

Date: 1/5/21	Scale:	Creator: JSM
--------------	--------	--------------