

Specifications

Housing Material: Powder Coated Galvanized Steel

Input Power: 120 VAC 60 Hz.

Power Consumption: 36.5 Va.

Total UV Output: 10 UVC Watts @ 254 nm

Number of Lamps: 1 - 22" UVC (AS-IH-1015, No Ozone production)

Electrical Connections: Multiple 1/2" & 3/4" Knockouts

Air Flow: 67 CFM

Noise Level: 34.00 dB Fan

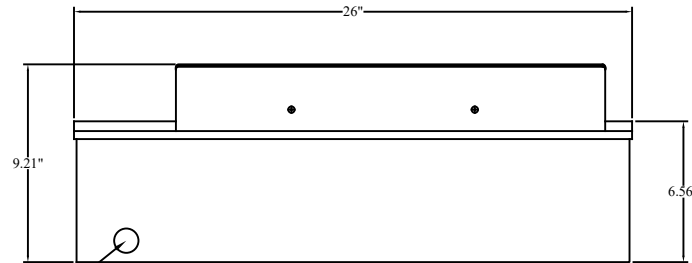
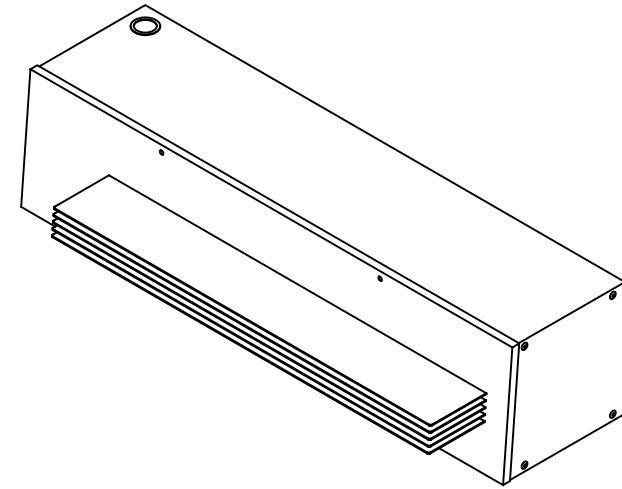

Electrical Connections

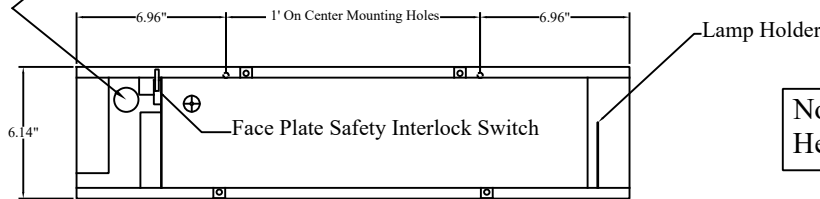

Note: Minimum Installation Height of 7' to Bottom of Fixture

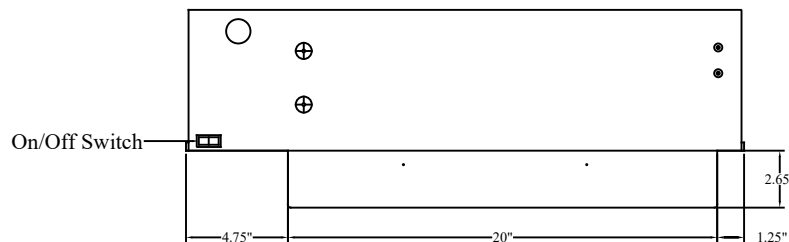
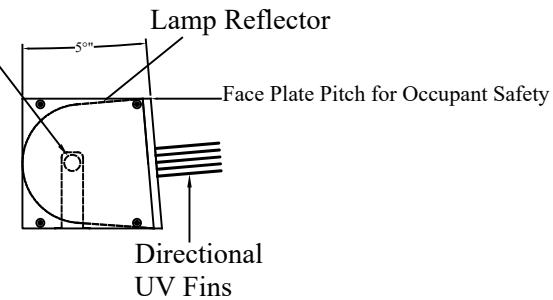
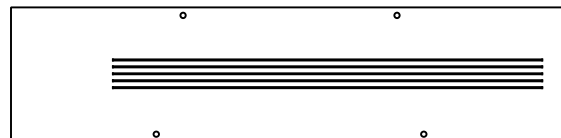
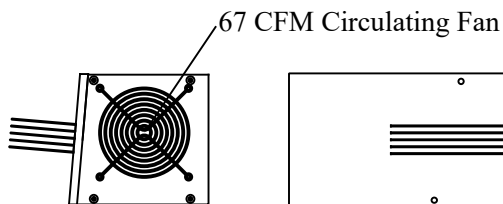

Ultravation, Inc.

212 Ideal Way.
Poultney, Vermont 05764.

Ph: 802-287-9735

Fx: 802-287-9203

www.Ultravation.com

Part #: UVMatrix FS-22F	Drawing #: FS22F-DSS	Rev - C
-------------------------	----------------------	---------

Description: BioGard Series UVMatrix FS-22F Upper Room UVC with 67 CFM fan for increased room circulation, Wall Mount installation with 1-22" Germicidal Lamp for Area Coverage of 225 ft² at maximum dimensions of 15' wide x 15' deep.

Date: 1/5/21

Scale:

Creator: JSM